



CATALOG

PRO AQUA

STILTE PLUS

SILENT
SEWAGE SYSTEMS

STEFAN
1879



STILTE PLUS

S I L E N T
SEWAGE SYSTEMS

CONTENTS

PRO AQUA factory	3
Production laboratory	3
PRO AQUA STILTE PLUS internal sewage	4
Key pipe specifications	4
System main advantages	5
Application area	5
Socket dimensions	6
Product range	6
Accessories	10
General requirements for design of internal sewage	11
Hydraulic calculation	12
Installation general recommendations	16
Fasteners	16
Pipeline installation procedure	17
Connections to other systems	17
Pipeline repair and fitting installation into mounted pipeline	17
Noise level	18
Installation of fire-protection collar	20
Transportation and storage	20
Approvals	21



These products were manufactured under the control established in the quality management system certified by Bureau Veritas Certification and complying with the requirements of ISO 9001: 2015, certificate no: RU003921

Nº: RU003921

PRO AQUA Factory



PRO AQUA FACTORY

The PRO AQUA factory is one of the largest manufacturers, producing polypropylene and polyethylene piping systems for internal and external utility networks since 2001. The company's production facility is equipped with modern high-precision European equipment. The factory has a certified laboratory which monitors the quality of all products manufactured at the factory. Thanks to constant monitoring, the products produced by the factory maintain consistently high quality. All products manufactured by the company have a warranty period of 10 years.

PRODUCTION LABORATORY

The production laboratory of the PRO AQUA factory is a structural subdivision with the functions of conducting technical control at all stages of the production process.

PRO AQUA factory is equipped with modern measuring instruments and equipment for testing polymer products from leading European manufacturers (ZWICK; BINDER; SCITEQ). The laboratory has been certified by FBU "The State Regional Centre for Standardization, Metrology and Testing" for the technical competence for a defined scope in accordance with the requirements of ISO / IEC 17025.

General

PRO AQUA STILTE PLUS pipes and fittings are the pipeline system for internal sewage with enhanced noise-absorbing features. PRO AQUA STILTE PLUS system is the first noiseless sewage of Russian production complying with the best practices of European market.

Wall thickness of PRO AQUA STILTE PLUS as compared to the thicknesses of conventional polypropylene sewage is increased at average by 70%. PRO AQUA STILTE PLUS pipes and fittings are manufactured of specialized highly filled noise-absorbing composite based on polypropylene, which density 1.8 times higher than pure polypropylene. This allows PRO AQUA STILTE PLUS pipes and fittings absorbing efficiently the noises that occur in sewage.

PRO AQUA STILTE PLUS assortment includes pipes and fittings of DN/OD 58, 110, 160 и 200 mm standard sizes. Outer diameter of PRO AQUA STILTE PLUS pipes and fittings complies with standard sizes of SML sewage, and may be combined with these pipes via a regular joint clamp for cast-iron pipes. Pipes and fittings feature a higher ring stiffness, resistance to high temperatures (shortly to 95°C).

Key pipe specifications

Description	Units	Value
Density, minimum	kg/m ³	1600
Coefficient of linear thermal expansion, maximum	°C ⁻¹	1,2x10 ⁻⁴
Tightness of socket joint at inner water pressure, minimum	MPa	0,05
Maximum temperature, short-term	°C	80
Maximum temperature, briefly	°C	95
Ring stiffness for Ø58, Ø110, SN pipes, minimum	kN/m ²	16
Ring stiffness for Ø160, Ø200, SN pipes, minimum	kN/m ²	6
Young's modulus, minimum	MPa	450
Yield strength at extension, minimum	MPa	19
Relative elongation at break, minimum	%	150
Poisson's ratio		0,4
Coefficient of thermal conductivity	W/m°C	0,2
Heat capacity	kJ/kg × °C	2,1
Permittivity @ 10 ⁶ Hz		2,2
Specific surface resistance	Ohm × m	4*10 ¹³
Pipe material		Composition of polypropylene and mineral filler
Pipe color		Light grey, RAL 7047
Sealing ring design		Single-lip
Sealing ring material		EPDM (ethylene-propylene-diene monomer)



PRO AQUA STILTE PLUS pipes and fittings are significantly lighter than cast-iron fittings, and in contrast to the SML system, pipe connection is performed in socket style, which is considerably quicker. Plastic pipes are not subject to corrosion, and not conduct electricity, which also increases reliability of the system. Thanks to the smooth surface, risk in clogging of pipe is reduced, and a higher resistance to wear ensures service life at least 50 years. Polypropylene pipelines do not require painting, or application of specialized protective coatings.

PRO AQUA STILTE PLUS pipes are produced using melt extrusion method, fittings use injection molding. Manufacture and quality control of pipes and fittings is performed according to the specifications NPO PRO AQUA TU 2248-011-16965449-2016.

System main advantages

- + Temperature resistance to 95°C i.e. higher than PVC and PE pipes by 30°C
- + Noise level to 10 times lower than sewage per EN 1451
- + Higher ring stiffness - good for underground application
- + Chemically inert and do not corrode. Unlike cast-iron pipes, no coating, which damage results in pipe corrosion
- + Impact resistance to 2 times higher than the common PP sewage
- + Do not require specialized clamps for attachment or joining (in contrast to SML pipes)
- + Lighter than cast-iron pipes and fittings by 3-5 times
- + Resistant to abrasive wear
- + Roughness lower than cast-iron pipes by 10 times i.e. risk of clogging is significantly reduced

Application area

PRO AQUA STILTE PLUS system is intended for installation of internal sewage in residential, production and administrative buildings. Noise-absorbing properties of these pipelines may be useful in premises of various purpose:

- kindergartens, schools, development centers and other children's institutions
- hospitals and sanatoriums
- hotel units, boarding houses
- residential multi-apartment buildings
- residential country houses
- research and production centers where high noise and vibration requirements are applied PRO AQUA STILTE PLUS system may be used in stormwater drainage systems in buildings up to 10 meters high.

PRO AQUA STILTE PLUS pipelines may be laid down under the ground. While the system installation shall be performed at temperature above 0 °C.

PRO AQUA STILTE PLUS pipelines may be applied as gravity pipelines for transportation of media, to which polypropylene and EPDM are chemically resistant. Detailed information about chemical resistance is shown in ISO/TR 10358

SOCKET DIMENSIONS

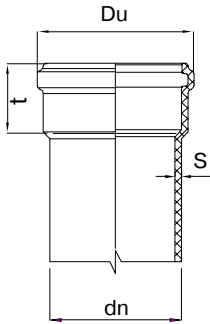

DN/OD, mm	dn, mm	Du, mm	t, mm	s, mm
58	58	76	55	4,00
110	110	132	60	5,30
160	160	186	75	5,30
200	200	229	94	6,20

PRODUCT RANGE

Silent sewage pipe with socket

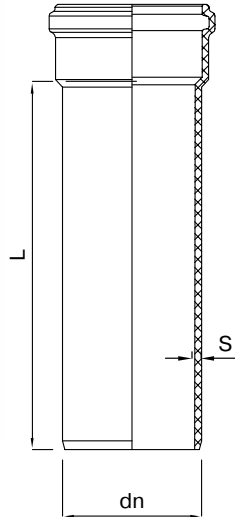

Code	dn, mm	L, mm	S, mm
STPL550580150	58	150	4,00
STPL550580250	58	250	4,00
STPL550580500	58	500	4,00
STPL550581000	58	1000	4,00
STPL550581500	58	1500	4,00
STPL550582000	58	2000	4,00
STPL550583000	58	3000	4,00
STPL551100150	110	150	5,30
STPL551100250	110	250	5,30
STPL551100500	110	500	5,30
STPL551101000	110	1000	5,30
STPL551101500	110	1500	5,30
STPL551102000	110	2000	5,30
STPL551103000	110	3000	5,30
STPL551600250	160	250	5,30
STPL551600500	160	500	5,30
STPL551601000	160	1000	5,30
STPL551602000	160	2000	5,30
STPL551603000	160	3000	5,30
STPL552000250	200	250	6,20
STPL552000500	200	500	6,20
STPL552001000	200	1000	6,20
STPL552002000	200	2000	6,20
STPL552003000	200	3000	6,20

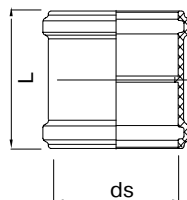

Double socket sliding coupling

Code	dn, mm	ds, mm	L mm
STPL30058	58	58	107
STPL30110	110	110	125
STPL30160	160	160	155
STPL30200	200	200	212

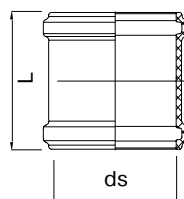

Repair coupling

Code	dn, mm	ds, mm	L mm
STPL31058	58	58,3	107
STPL31110	110	110,4	125
STPL31160	160	160,5	155
STPL31200	200	200,6	212

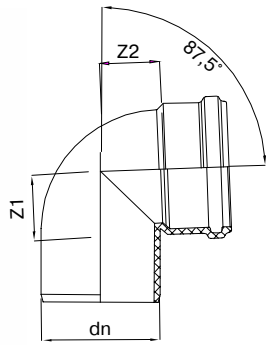

Elbow 87.5°

Code	dn, mm	Z1, mm	Z2, mm
STPL1005887	58	35	33
STPL1011087	110	60	60
STPL1016087	160	84	91
STPL1020087	200	105	113

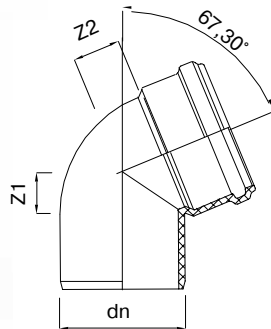

Elbow 67°

Code	dn, mm	Z1, mm	Z2, mm
STPL1005867	58	26	25
STPL1011067	110	42	47

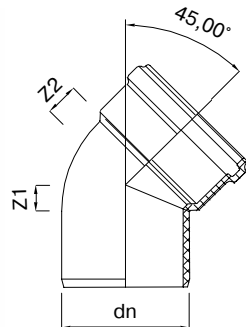

Elbow 45°

Code	dn, mm	Z1, mm	Z2, mm
STPL1005845	58	18	19
STPL1011045	110	28	31
STPL1016045	160	37	42
STPL1020045	200	50	57

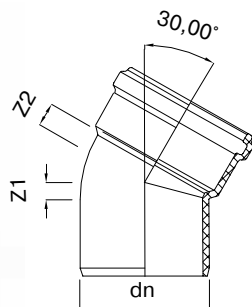

Elbow 30°

Code	dn, mm	Z1, mm	Z2, mm
STPL1005830	58	13	15
STPL1011030	110	20	22
STPL1016030	160		

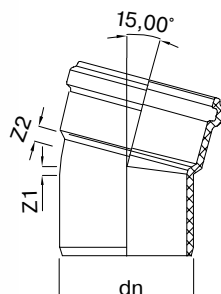

Elbow 15°

Code	dn, mm	Z1, mm	Z2, mm
STPL1005815	58	4	9
STPL1011015	110	7	13

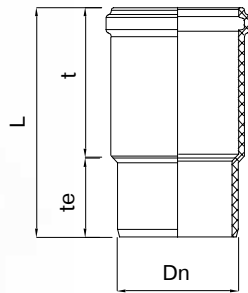

Compensation socket

Code	dn, mm	L, mm	t, mm	te, mm
STPL90110	110	204	130	74

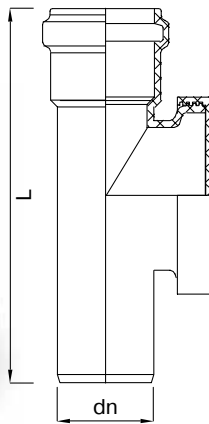

Inspection tee

Code	dn, mm	L, mm
STPL60058	58	224
STPL60110	110	350
STPL60160	160	440

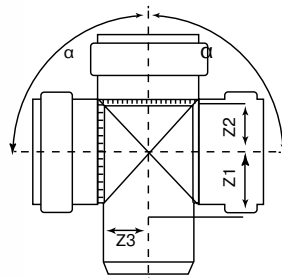

Cross

Code	dn, mm	Z1, mm	Z2, mm	Z3, mm	α°
STPL801187	110	56	60	60	87,5

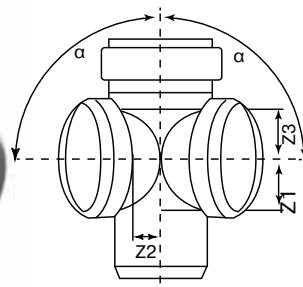

Corner cross

Code	dn, mm	Z1, mm	Z2, mm	Z3, mm	α°
STPL801187	110	59	73	62	87,5

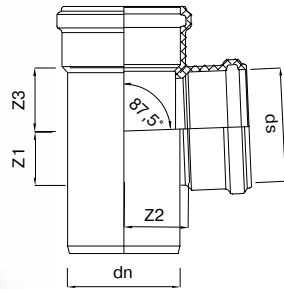

Branch 87.5°

Code	dn, mm	ds, mm	Z1, mm	Z2, mm	Z3, mm
STPL2005805887	58	58	39	35	35
STPL2011011087	110	110	60	62	62
STPL2011005887	110	58	32	61	34
STPL2016016087	160	160	77	90	90
STPL2020011087	200	110	-	-	-
STPL2020016087	200	160	-	-	-

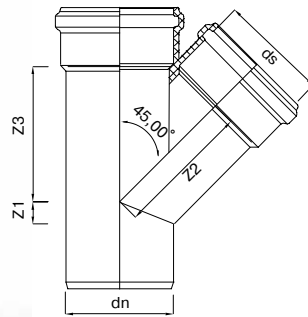

Branch 45°

Code	dn, mm	ds, mm	Z1, mm	Z2, mm	Z3, mm
STPL2005805845	58	58	13	74	74
STPL2011011045	110	110	28	137	137
STPL2016016045	160	160	37	195	195
STPL2020020045	200	200	51	251	251
STPL2011005845	110	58	8	108	95
STPL2016011045	160	110	-	-	-
STPL2020016045	200	160	-	-	-

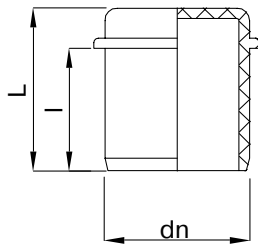

Plug

Code	dn, mm	L, mm	l, mm
STPL40058	58	65	49
STPL40110	110	41	36
STPL40160	160	51	47
STPL40200	200	108	82

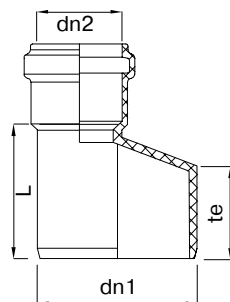

Eccentric reducer

Code	dn2, mm	dn1, mm	L, mm	te, mm
STPL50058040	58	40	72	61
STPL50058050	58	50	68	61
STPL50110058	110	58	92	63
STPL50160110	160	110	109	85
STPL50200110	200	110	-	-
STPL50200160	200	160	131	107

ACCESSORIES

PRO AQUA STILTE PLUS is also completed with accessories for PRO AQUA Comfort sewage. These components feature a standard wall thickness, do not possess noise-absorbing properties, and applied external demanding noise protection i.e. at garrets, in basements, on building roof or in areas that adjoin directly the sewage sources where the flow still did not reached sufficient velocity, and do not generate significant noise. The list of these articles is given below.



Check valve

Serves to prevent back flow of liquid in sewage systems

Code	Description	Standard size
930050	Check valve	50*
930110	Check valve	110

* Connection is performed via 2 adapters 58/50, and a piece of PRO AQUA Comfort/PRO AQUA Stilte pipe



Air admittance valve (aerator)

Installed on non-vented standpipes, and prevents breakdown of hydraulic seals. Air valve may be installed at a height that exceeds upper connection point, at least by 30 cm

Code	Description	Standard size
950050	PP vacuum valve AirBalance	50*
950110	PP aerator (vacuum valve)	110

* Connection is performed via 58/50 adapter



Floor drain

Code	Grill type	Pipe bend type	Standard size
9-2610-050-46-01-04	Plastic, 100x100	Vertical	50*
9-2610-050-47-01-04	Plastic, 100x100	Horizontal	50*
9-2600-050-46-01-04	Stainless steel, 100x100	Vertical	50*
9-2600-110-46-01-04	Stainless steel, 150x150	Vertical	110
9-2600-050-47-01-04	Stainless steel, 100x100	Horizontal	50*
9-2600-110-47-01-04	Stainless steel, 150x150	Horizontal	110

* Connection is performed via 58/50 adapter



Deflector

(vent hood, 'mushroom', ventilation exhaust)
Required to protect vented standpipe against ingress of rainfall, and foreign items.

Code	Description	Standard size
940110	PP vent hood	110
9-3003-160-37-01-03	PP Deflector	160
2910	PP Deflector	50



WC connection

Code	Description	Standard size
498043	Connection to toilet bowl	110 x 45°
498044	Connection to toilet bowl	110 x 87,5°
540100	Connection to toilet bowl	110 straight



Cast iron pipe adaptor with socket

Code	Description	Standard size
920050	Adapter for smooth PP pipe	50 x 73*
920110	Adapter for smooth PP pipe	110 x 123

* Connection is performed via 2 adapters 58/50, and a piece of PRO AQUA Comfort/PRO AQUA Stilte pipe



Cast iron pipe adaptor

Code	Description	Standard size
150075	Adapter for socket of PP pipe	50 x 73*
124110	Adapter for socket of PP pipe	110 x 123

* Connection is performed via 2 adapters 58/50, and a piece of PRO AQUA Comfort/PRO AQUA Stilte pipe

General requirements for design of internal sewage

Any pipeline shall be calculated so as at a calculated runoff flowrate they operate in a free flow mode. During construction of buildings at a height over two storeys, inspection tees on sewage standpipe shall be installed on every third storey. At a concealed installation, free access to the pipeline cleanup locations shall be ensured by installing doors, removable panels, grills etc. Whenever possible, application of branches and elbows with 87.5° angle shall be avoided. It is better to use two fittings with 45° angle or three ones with 30° angle instead. When performing a turn at 90° using two 45° elbows, it is recommended to install stabilizing section of pipe segment at a length at least 2 DN between the elbows.

Hydraulic calculation

Flow velocity V, m/s, and pipeline filling, h/D shall be assigned so as to satisfy the following conditions.

$$\begin{aligned}
 h/d &\geq 0,3 \\
 V &\geq 0,7 \\
 v \sqrt{\frac{h}{D}} &\geq 0,5
 \end{aligned}$$

In the cases when the last condition is impracticable due too insufficient value for wastewater flowrate, inclination shall be taken equal to 1/D.

In the other cases hydraulic gradient of pipeline shall be determined using formulas from SP 40-102-2000, or the tables below:

Stilte Plus pipe 58 mm, Di=49.7 mm															
h/d	i=0,005		i=0,01		i=0,015		i=0,02		i=0,025		i=0,03		i=0,035		
	Q, L/s	V, m/s	Q, L/s	V, m/s	Q, L/s	V, m/s	Q, L/s	V, m/s	Q, L/s	V, m/s	Q, L/s	V, m/s	Q, L/s	V, m/s	
0,3	0,11	0,21	0,15	0,30	0,18	0,37	0,21	0,43	0,24	0,48	0,26	0,52	0,28	0,56	
0,35	0,14	0,23	0,20	0,33	0,25	0,40	0,28	0,46	0,32	0,52	0,35	0,57	0,37	0,61	
0,4	0,18	0,25	0,26	0,35	0,31	0,43	0,36	0,50	0,41	0,55	0,44	0,61	0,48	0,66	
0,45	0,22	0,26	0,32	0,37	0,39	0,45	0,45	0,52	0,50	0,59	0,55	0,64	0,59	0,69	
0,5	0,27	0,27	0,38	0,39	0,47	0,48	0,54	0,55	0,60	0,61	0,66	0,67	0,71	0,73	
0,55	0,32	0,29	0,45	0,40	0,55	0,49	0,63	0,57	0,71	0,64	0,77	0,70	0,84	0,75	
0,6	0,36	0,29	0,51	0,42	0,63	0,51	0,72	0,59	0,81	0,66	0,89	0,72	0,96	0,78	
0,65	0,41	0,30	0,58	0,43	0,71	0,52	0,82	0,60	0,91	0,67	1,00	0,74	1,08	0,80	
0,7	0,45	0,31	0,64	0,43	0,78	0,53	0,90	0,61	1,01	0,69	1,11	0,75	1,19	0,81	
0,75	0,49	0,31	0,70	0,44	0,85	0,54	0,98	0,62	1,10	0,70	1,20	0,76	1,30	0,82	
0,8	0,53	0,31	0,75	0,44	0,91	0,54	1,05	0,63	1,18	0,70	1,29	0,77	1,39	0,83	
0,85	0,56	0,31	0,79	0,44	0,96	0,54	1,11	0,62	1,24	0,70	1,36	0,76	1,47	0,83	
0,9	0,57	0,31	0,81	0,44	1,00	0,53	1,15	0,62	1,28	0,69	1,41	0,76	1,52	0,82	
0,95	0,58	0,30	0,82	0,43	1,00	0,52	1,16	0,60	1,30	0,67	1,42	0,74	1,53	0,80	
1	0,54	0,27	0,76	0,39	0,93	0,48	1,08	0,55	1,21	0,61	1,32	0,67	1,43	0,73	

Stilte Plus pipe 58 mm, Di=49.7 mm															
h/d	i=0,04		i=0,045		i=0,05		i=0,055		i=0,06		i=0,065		i=0,07		
	Q, L/s	V, m/s	Q, L/s	V, m/s	Q, L/s	V, m/s	Q, L/s	V, m/s	Q, L/s	V, m/s	Q, L/s	V, m/s	Q, L/s	V, m/s	
0,3	0,30	0,60	0,32	0,64	0,33	0,67	0,35	0,71	0,37	0,74	0,38	0,77	0,39	0,80	
0,35	0,40	0,65	0,42	0,69	0,45	0,73	0,47	0,77	0,49	0,80	0,51	0,83	0,53	0,87	
0,4	0,51	0,70	0,54	0,74	0,57	0,78	0,60	0,82	0,63	0,86	0,65	0,89	0,68	0,93	
0,45	0,63	0,74	0,67	0,79	0,71	0,83	0,74	0,87	0,78	0,91	0,81	0,94	0,84	0,98	
0,5	0,76	0,78	0,81	0,82	0,85	0,87	0,89	0,91	0,93	0,95	0,97	0,99	1,01	1,03	
0,55	0,89	0,81	0,95	0,86	1,00	0,90	1,05	0,95	1,09	0,99	1,14	1,03	1,18	1,07	
0,6	1,02	0,83	1,09	0,88	1,15	0,93	1,20	0,98	1,25	1,02	1,31	1,06	1,35	1,10	
0,65	1,15	0,85	1,22	0,91	1,29	0,95	1,35	1,00	1,41	1,05	1,47	1,09	1,53	1,13	
0,7	1,28	0,87	1,35	0,92	1,43	0,97	1,50	1,02	1,56	1,06	1,63	1,11	1,69	1,15	
0,75	1,39	0,88	1,47	0,93	1,55	0,98	1,63	1,03	1,70	1,08	1,77	1,12	1,84	1,16	
0,8	1,49	0,88	1,58	0,94	1,67	0,99	1,75	1,04	1,83	1,08	1,90	1,13	1,97	1,17	
0,85	1,57	0,88	1,67	0,94	1,76	0,99	1,84	1,04	1,92	1,08	2,00	1,13	2,08	1,17	
0,9	1,62	0,87	1,72	0,93	1,82	0,98	1,91	1,02	1,99	1,07	2,07	1,11	2,15	1,15	
0,95	1,64	0,85	1,74	0,90	1,83	0,95	1,92	1,00	2,01	1,04	2,09	1,08	2,17	1,12	
1	1,52	0,78	1,62	0,82	1,70	0,87	1,79	0,91	1,87	0,95	1,94	0,99	2,02	1,03	

h/d	Stilte Plus pipe 110 mm, Di=99.3 mm													
	i=0,005		i=0,01		i=0,015		i=0,02		i=0,025		i=0,03		i=0,035	
	Q, L/s	V, m/s	Q, L/s	V, m/s	Q, L/s	V, m/s	Q, L/s	V, m/s	Q, L/s	V, m/s	Q, L/s	V, m/s	Q, L/s	V, m/s
0,3	0,66	0,34	0,93	0,48	1,14	0,58	1,32	0,67	1,47	0,75	1,61	0,82	1,74	0,89
0,35	0,88	0,37	1,25	0,52	1,53	0,63	1,77	0,73	1,98	0,82	2,16	0,90	2,34	0,97
0,4	1,13	0,39	1,60	0,55	1,96	0,68	2,26	0,78	2,53	0,88	2,77	0,96	3,00	1,04
0,45	1,40	0,41	1,98	0,59	2,42	0,72	2,80	0,83	3,13	0,93	3,43	1,01	3,70	1,10
0,5	1,68	0,43	2,38	0,61	2,91	0,75	3,36	0,87	3,76	0,97	4,12	1,06	4,45	1,15
0,55	1,97	0,45	2,78	0,64	3,41	0,78	3,94	0,90	4,40	1,01	4,82	1,10	5,21	1,19
0,6	2,26	0,47	3,19	0,66	3,91	0,81	4,52	0,93	5,05	1,04	5,53	1,14	5,97	1,23
0,65	2,54	0,48	3,60	0,67	4,40	0,83	5,09	0,95	5,69	1,07	6,23	1,17	6,73	1,26
0,7	2,81	0,49	3,98	0,69	4,87	0,84	5,63	0,97	6,29	1,09	6,89	1,19	7,45	1,29
0,75	3,07	0,49	4,34	0,70	5,31	0,85	6,13	0,98	6,85	1,10	7,51	1,21	8,11	1,30
0,8	3,29	0,49	4,65	0,70	5,69	0,86	6,57	0,99	7,35	1,11	8,05	1,21	8,69	1,31
0,85	3,46	0,49	4,90	0,70	6,00	0,86	6,93	0,99	7,75	1,10	8,48	1,21	9,16	1,31
0,9	3,58	0,49	5,07	0,69	6,21	0,85	7,17	0,98	8,01	1,09	8,78	1,20	9,48	1,29
0,95	3,61	0,48	5,11	0,67	6,26	0,82	7,22	0,95	8,08	1,06	8,85	1,16	9,56	1,26
1	3,36	0,43	4,75	0,61	5,82	0,75	6,72	0,87	7,52	0,97	8,23	1,06	8,89	1,15

h/d	Stilte Plus pipe 110 mm, Di=99.3 mm													
	i=0,04		i=0,045		i=0,05		i=0,055		i=0,06		i=0,065		i=0,07	
	Q, L/s	V, m/s	Q, L/s	V, m/s	Q, L/s	V, m/s	Q, L/s	V, m/s	Q, L/s	V, m/s	Q, L/s	V, m/s	Q, L/s	V, m/s
0,3	1,86	0,95	1,97	1,01	2,08	1,06	2,18	1,12	2,28	1,17	2,37	1,21	2,46	1,26
0,35	2,50	1,03	2,65	1,10	2,79	1,16	2,93	1,21	3,06	1,27	3,19	1,32	3,31	1,37
0,4	3,20	1,11	3,40	1,17	3,58	1,24	3,76	1,30	3,92	1,36	4,08	1,41	4,24	1,46
0,45	3,96	1,17	4,20	1,24	4,43	1,31	4,64	1,37	4,85	1,43	5,05	1,49	5,24	1,55
0,5	4,75	1,23	5,04	1,30	5,31	1,37	5,57	1,44	5,82	1,50	6,06	1,56	6,29	1,62
0,55	5,57	1,28	5,91	1,35	6,23	1,43	6,53	1,50	6,82	1,56	7,10	1,63	7,37	1,69
0,6	6,39	1,32	6,77	1,40	7,14	1,47	7,49	1,54	7,82	1,61	8,14	1,68	8,45	1,74
0,65	7,19	1,35	7,63	1,43	8,04	1,51	8,43	1,58	8,81	1,65	9,17	1,72	9,51	1,79
0,7	7,96	1,37	8,44	1,46	8,90	1,54	9,33	1,61	9,75	1,68	10,15	1,75	10,53	1,82
0,75	8,67	1,39	9,20	1,48	9,69	1,56	10,17	1,63	10,62	1,70	11,05	1,77	11,47	1,84
0,8	9,29	1,40	9,86	1,48	10,39	1,56	10,90	1,64	11,38	1,71	11,85	1,78	12,29	1,85
0,85	9,80	1,40	10,39	1,48	10,95	1,56	11,49	1,64	12,00	1,71	12,49	1,78	12,96	1,85
0,9	10,13	1,38	10,75	1,46	11,33	1,54	11,88	1,62	12,41	1,69	12,92	1,76	13,41	1,83
0,95	10,22	1,34	10,84	1,43	11,42	1,50	11,98	1,58	12,51	1,65	13,02	1,71	13,51	1,78
1	9,51	1,23	10,08	1,30	10,63	1,37	11,15	1,44	11,64	1,50	12,12	1,56	12,58	1,62

SILENT SEWAGE

Stilte Plus pipe 160 mm, Di=149.6 mm														
h/d	i=0,005		i=0,01		i=0,015		i=0,02		i=0,025		i=0,03		i=0,035	
	Q, L/s	V, m/s	Q, L/s	V, m/s	Q, L/s	V, m/s	Q, L/s	V, m/s	Q, L/s	V, m/s	Q, L/s	V, m/s	Q, L/s	V, m/s
0,3	1,96	0,44	2,78	0,63	3,40	0,77	3,93	0,89	4,39	0,99	4,81	1,08	5,19	1,17
0,35	2,64	0,48	3,73	0,68	4,57	0,83	5,27	0,96	5,90	1,08	6,46	1,18	6,98	1,27
0,4	3,38	0,51	4,78	0,73	5,85	0,89	6,76	1,03	7,56	1,15	8,28	1,26	8,94	1,36
0,45	4,18	0,54	5,91	0,77	7,23	0,94	8,35	1,09	9,34	1,22	10,23	1,33	11,05	1,44
0,5	5,01	0,57	7,09	0,81	8,69	0,99	10,03	1,14	11,21	1,28	12,28	1,40	13,27	1,51
0,55	5,87	0,59	8,31	0,84	10,17	1,03	11,75	1,19	13,14	1,33	14,39	1,45	15,54	1,57
0,6	6,74	0,61	9,53	0,87	11,67	1,06	13,48	1,22	15,07	1,37	16,51	1,50	17,83	1,62
0,65	7,59	0,63	10,73	0,89	13,14	1,09	15,17	1,25	16,97	1,40	18,58	1,54	20,07	1,66
0,7	8,40	0,64	11,88	0,90	14,55	1,11	16,80	1,28	18,78	1,43	20,57	1,57	22,22	1,69
0,75	9,15	0,65	12,94	0,91	15,84	1,12	18,29	1,29	20,45	1,45	22,40	1,58	24,20	1,71
0,8	9,80	0,65	13,87	0,92	16,98	1,13	19,61	1,30	21,92	1,45	24,02	1,59	25,94	1,72
0,85	10,34	0,65	14,62	0,92	17,90	1,12	20,67	1,30	23,11	1,45	25,32	1,59	27,35	1,72
0,9	10,69	0,64	15,12	0,91	18,52	1,11	21,38	1,28	23,90	1,43	26,19	1,57	28,28	1,70
0,95	10,78	0,62	15,24	0,88	18,67	1,08	21,56	1,25	24,10	1,40	26,40	1,53	28,51	1,65
1	10,03	0,57	14,18	0,81	17,37	0,99	20,06	1,14	22,43	1,28	24,57	1,40	26,53	1,51

Stilte Plus pipe 160 mm, Di=149.6 mm														
h/d	i=0,04		i=0,045		i=0,05		i=0,055		i=0,06		i=0,065		i=0,07	
	Q, L/s	V, m/s	Q, L/s	V, m/s	Q, L/s	V, m/s	Q, L/s	V, m/s	Q, L/s	V, m/s	Q, L/s	V, m/s	Q, L/s	V, m/s
0,3	5,55	1,25	5,89	1,33	6,21	1,40	6,51	1,47	6,80	1,53	7,08	1,60	7,35	1,66
0,35	7,46	1,36	7,91	1,44	8,34	1,52	8,74	1,59	9,13	1,67	9,51	1,73	9,86	1,80
0,4	9,56	1,46	10,14	1,54	10,69	1,63	11,21	1,71	11,71	1,78	12,18	1,86	12,64	1,93
0,45	11,81	1,54	12,53	1,63	13,21	1,72	13,85	1,81	14,47	1,89	15,06	1,96	15,63	2,04
0,5	14,18	1,61	15,04	1,71	15,86	1,80	16,63	1,89	17,37	1,98	18,08	2,06	18,76	2,13
0,55	16,62	1,68	17,62	1,78	18,58	1,88	19,48	1,97	20,35	2,05	21,18	2,14	21,98	2,22
0,6	19,06	1,73	20,22	1,84	21,31	1,94	22,35	2,03	23,34	2,12	24,30	2,21	25,21	2,29
0,65	21,46	1,77	22,76	1,88	23,99	1,98	25,16	2,08	26,28	2,17	27,36	2,26	28,39	2,35
0,7	23,75	1,81	25,19	1,92	26,56	2,02	27,85	2,12	29,09	2,21	30,28	2,30	31,42	2,39
0,75	25,87	1,83	27,44	1,94	28,92	2,05	30,34	2,15	31,69	2,24	32,98	2,33	34,22	2,42
0,8	27,73	1,84	29,41	1,95	31,01	2,06	32,52	2,16	33,96	2,25	35,35	2,35	36,69	2,43
0,85	29,23	1,84	31,01	1,95	32,69	2,05	34,28	2,15	35,81	2,25	37,27	2,34	38,67	2,43
0,9	30,24	1,81	32,07	1,92	33,81	2,03	35,46	2,13	37,03	2,22	38,55	2,31	40,00	2,40
0,95	30,48	1,77	32,33	1,87	34,08	1,98	35,75	2,07	37,33	2,16	38,86	2,25	40,33	2,34
1	28,37	1,61	30,09	1,71	31,71	1,80	33,26	1,89	34,74	1,98	36,16	2,06	37,53	2,13

h/d	Stilte Plus pipe 200 mm, Di=187.5 mm													
	i=0,005		i=0,01		i=0,015		i=0,02		i=0,025		i=0,03		i=0,035	
	Q, L/s	V, m/s	Q, L/s	V, m/s	Q, L/s	V, m/s	Q, L/s	V, m/s	Q, L/s	V, m/s	Q, L/s	V, m/s	Q, L/s	V, m/s
0,3	3,59	0,51	5,07	0,73	6,21	0,89	7,17	1,03	8,02	1,15	8,78	1,26	9,49	1,36
0,35	4,82	0,56	6,81	0,79	8,34	0,97	9,63	1,12	10,77	1,25	11,79	1,37	12,74	1,48
0,4	6,17	0,60	8,73	0,85	10,69	1,04	12,34	1,20	13,80	1,34	15,12	1,47	16,33	1,58
0,45	7,63	0,63	10,79	0,90	13,21	1,10	15,26	1,27	17,06	1,42	18,69	1,55	20,19	1,67
0,5	9,16	0,66	12,95	0,94	15,86	1,15	18,32	1,33	20,48	1,48	22,43	1,62	24,23	1,76
0,55	10,73	0,69	15,17	0,98	18,58	1,19	21,46	1,38	23,99	1,54	26,28	1,69	28,39	1,82
0,6	12,31	0,71	17,41	1,01	21,32	1,23	24,61	1,42	27,52	1,59	30,15	1,74	32,56	1,88
0,65	13,86	0,73	19,60	1,03	24,00	1,26	27,71	1,46	30,99	1,63	33,94	1,79	36,66	1,93
0,7	15,34	0,74	21,69	1,05	26,57	1,29	30,68	1,49	34,30	1,66	37,57	1,82	40,58	1,97
0,75	16,71	0,75	23,63	1,06	28,93	1,30	33,41	1,50	37,35	1,68	40,92	1,84	44,20	1,99
0,8	17,91	0,76	25,32	1,07	31,02	1,31	35,81	1,51	40,04	1,69	43,86	1,85	47,38	2,00
0,85	18,88	0,75	26,70	1,07	32,70	1,31	37,76	1,51	42,21	1,69	46,24	1,85	49,95	2,00
0,9	19,53	0,75	27,61	1,05	33,82	1,29	39,05	1,49	43,66	1,67	47,83	1,83	51,66	1,97
0,95	19,68	0,73	27,84	1,03	34,09	1,26	39,37	1,45	44,02	1,62	48,22	1,78	52,08	1,92
1	18,32	0,66	25,90	0,94	31,73	1,15	36,63	1,33	40,96	1,48	44,87	1,62	48,46	1,76

h/d	Stilte Plus pipe 200 mm, Di=187.5 mm													
	i=0,04		i=0,045		i=0,05		i=0,055		i=0,06		i=0,065		i=0,07	
	Q, L/s	V, m/s	Q, L/s	V, m/s	Q, L/s	V, m/s	Q, L/s	V, m/s	Q, L/s	V, m/s	Q, L/s	V, m/s	Q, L/s	V, m/s
0,3	10,14	1,46	10,76	1,54	11,34	1,63	11,89	1,71	12,42	1,78	12,93	1,86	13,42	1,93
0,35	13,62	1,58	14,45	1,68	15,23	1,77	15,97	1,85	16,68	1,94	17,36	2,02	18,02	2,09
0,4	17,46	1,69	18,52	1,80	19,52	1,89	20,47	1,98	21,38	2,07	22,25	2,16	23,09	2,24
0,45	21,58	1,79	22,89	1,90	24,13	2,00	25,30	2,10	26,43	2,19	27,51	2,28	28,55	2,37
0,5	25,90	1,88	27,48	1,99	28,96	2,10	30,38	2,20	31,73	2,30	33,02	2,39	34,27	2,48
0,55	30,35	1,95	32,19	2,07	33,93	2,18	35,58	2,29	37,17	2,39	38,68	2,49	40,14	2,58
0,6	34,81	2,01	36,92	2,13	38,92	2,25	40,82	2,36	42,63	2,46	44,37	2,57	46,05	2,66
0,65	39,19	2,06	41,57	2,19	43,82	2,31	45,96	2,42	48,00	2,53	49,96	2,63	51,85	2,73
0,7	43,38	2,10	46,01	2,23	48,50	2,35	50,87	2,46	53,13	2,57	55,30	2,68	57,39	2,78
0,75	47,25	2,13	50,12	2,26	52,83	2,38	55,41	2,49	57,87	2,61	60,23	2,71	62,51	2,81
0,8	50,65	2,14	53,72	2,27	56,63	2,39	59,39	2,51	62,03	2,62	64,57	2,73	67,00	2,83
0,85	53,39	2,13	56,63	2,26	59,70	2,39	62,61	2,50	65,39	2,61	68,06	2,72	70,63	2,82
0,9	55,23	2,11	58,58	2,24	61,74	2,36	64,76	2,47	67,64	2,58	70,40	2,69	73,06	2,79
0,95	55,68	2,05	59,05	2,18	62,25	2,30	65,29	2,41	68,19	2,52	70,97	2,62	73,65	2,72
1	51,81	1,88	54,95	1,99	57,92	2,10	60,75	2,20	63,45	2,30	66,04	2,39	68,54	2,48

INSTALLATION GENERAL RECOMMENDATIONS

Sewage system installation methods

The following methods are applied when installing indoor sewage mains:

Exposed - in in the underground, basements, workshops, utility and auxiliary premises, corridors, technical storeys, and special premises designed to accommodate mains with attachments to the structures of buildings, as well as on special supports.

Concealed - with embedment in the civil structures of floor slabs, under floors, in panels, furrows of the walls, under cladding of the columns, in suspended ceilings, toilet cubicles, vertical shafts. The concealed installation shall ensure compensation for deformations without mechanical damage, the inner surface shall not have hard sharp protrusions.

The concealed installation shall be preferred as far as possible. When mechanical damage to the pipeline is possible, pipelines may be installed concealed only.

Pipelines shall not adjoin close to the surface of civil structures. The distance in the clear between the pipes and civil structures shall be at least 20 mm.

Installation through the floor slabs - locations where standpipes pass through the floor slabs may be closed with cement grout to the entire thickness of the floor slab. When installing the pipes in the floor slab, they shall be wrapped with waterproof material.

Fasteners

The maximum distance between the fixed supports shall be determined based on the maximum compensating capacity of the socket, which is taken according to the following table:

DN	Compensating capacity of the socket
58	13 mm
110	15 mm
160	17 mm
200	22 mm

The maximum distance between the movable supports shall not exceed 10 D for the horizontal section, and 20 D for the vertical one. Thus, the following distances between the fasteners are taken:

DN	Distance between supports, maximum, m			
	Fixed supports, 2 sockets at a section between them	Fixed supports, 1 sockets at a section between them	Movable supports, horizontal section	Movable supports, vertical section
58	3,6	1,8	0,6	1,2
110	4,0	2,0	1,1	2,2
160	4,6	2,3	1,6	3,2
200	6,0	3,0	2,0	4,0

WLC noise absorbing clamps are recommended to be applied as the fixed supports. It is allowed to use conventional clamps having a cushioning gasket made of elastomer. Clamps of the same standard sizes not fully tightened may be used as movable (sliding) supports.

Do not apply plastic latches/clamps for Stille Plus system due to the heavy weight of the system. Fasteners shall ensure hydraulic gradient and alignment of pipeline parts.

Fasteners shall direct the forces arising from the extension of the pipeline towards the connections used as a compensator.

Compensatory sockets shall be used to ensure the required connection slopes, and in cases where the distance between the supports exceeds the recommended one.

Before installation of pipelines and fixing of fasteners, it is necessary to attach properly sanitary fixture, rainwater heads, and other wastewater receptors to the civil structures.

Vertical sections of the pipeline shall have fasteners installed under the socket, and on branch pipes used for connection to the toilet bowl and floor drain mains.

Do not attach the pipelines using the socket.

To reduce the noise, it is recommended to attach pipes to the walls with a density at least 220 kg/m²

PIPELINE INSTALLATION PROCEDURE

Installation shall be performed at a temperature not lower than minus 10 °C. Rubber seals, which were stored at a temperature below minus 25 °C shall be maintained for 24 hours at a temperature not lower than 15 °C.

- 1 When needed, cut the pipes at a right angle to the desired length. Pipes shall be cut by a pipe cutter or a saw with small teeth. Do not shorten the fittings.
- 2 On the spigot, chamfer the outer surface at an angle of 15°C using a special cutter or a file. Fittings and pipes not exposed to shortening have a factory made chamfer.
- 3 Inspect whether the sealing ring is installed correctly. Sealing ring shall be installed in the groove straightly, without protruding ends. The leaf of sealing ring shall be directed inside the socket.
- 4 Clean the spigot and sockets from dirt.
- 5 Mark the depth for leading in the spigot into the socket. The following lengths are recommended at an installation temperature of 20 °C:

DN, mm	Depth for insertion of spigot into the socket, mm
58	40
110	41
160	44
200	48

At installation temperature 0° insertion depth shall be reduced by 2-3 mm, at installation temperature 40 °C it shall be increased by 2-3mm.

- 6 Apply lubricant to the beveled surface of chamfer on the spigot.
- 7 Insert the spigot into the socket to the mark applied earlier.

During installation, it is allowed to insert the pipe until it stops, then withdrawing them to the length equal to the compensating ability of the socket.

Connecting to other systems

PRO AQUA STILTE PLUS Ø 110-200 pipes are fully compatible with polypropylene sewage according to EN 1451 from various manufacturers, as well as with all common market systems of low noise and noiseless plastic sewage. PRO AQUA STILTE PLUS Ø 110 pipes and over shall be installed with PRO AQUA COMFORT, OTK, PRO AQUA TERRA, PRO AQUA STILTE pipes.

To join the pipes with less diameter, there are 58/50 and 58/40 adapters, which socket portion DN 50 or DN 40 accordingly is compatible with the pipes per EN 1451.

Regular joint clamps, for instance, PAM Rapid S-W2 clamps may be applied to connect SML pipes.

The tightening forces shall be similar for cast-iron pipes.

To switch to the sewerage of grey cast-iron, regular cast-iron adaptors from PRO AQUA COMFORT system are applied.

Pipeline repair and fitting installation into mounted pipeline

Additional installation (tap-in) of fittings into an existing pipeline is possible with the use of sliding (repair) couplings.

Installation procedure:

- + cut off a necessary length of installed pipe. Length of removed pipe should be equal length of installing fitting + 2-3 OD
- + prepare additional short pipe section with length equal 2-3 OD (depends of length of removed pipe)
- + remove deburr from cutted edges, chamfer the outer surface
- + instal fitting to spigot of the upper pipe
- + instal one sliding coupling on short pipe section
- + instal other sliding coupling to spigot of bottom pipe
- + insert short pipe section
- + move sliding couplings to fix the short pipe section
- + fix short pipe section, using fixed support



NOISE LEVEL

The sources of noise in the sewerage system are connection, turn locations, shutoff valves. At these points, flow of liquid colliding with the walls and each other generate noise, which can then spread through the pipeline.

Noises in a sewage are divided by 2 types:

- airborne ones propagating from the walls of the pipeline directly through the air;
- structural ones transmitted through the pipe wall via the fasteners to the civil structures, and penetrating into the premises from them.

In addition to the fact that the sewage is a source of noise itself, the pipes passing through several storeys may contribute to the spread of external noise from one premise to another.

On average, in denser materials, the speed of sound propagation is higher, respectively, the wavelength for sounds of the same frequency is longer, and sounds travel a greater distance.

On the other hand, the heavier the pipe, the less it is subject to fluctuations in the collision of the liquid flow with its wall, and it generates the less noise respectively.

Increase in the wall thickness affects the noise-absorbing properties of the pipe positively preventing airborne noises from inside the pipe to penetrate into the external premise.

Thus, the task of designing a noiseless sewage reduced to the selection of the optimal composition, which at a sufficient weight and resistance to vibrations, will not have an excessive speed of sound wave propagation, and to increase of wall thickness to the values sufficient to absorb the airborne noises.

Comparison of some physical specifications of different sewage pipes Ø 110 (DN 100) is given in the table:

	Grey cast-iron pipes GOST 6942-98	SML pipes	PP pipes EN 1451	Sewage with enhanced noise absorption, manufacturer A, Russia	Sewage with enhanced noise absorption, manufacturer B, Germany	Sewage with enhanced noise absorption, manufacturer C, Germany	STILTE PLUS
Wall thickness	4,5	3,5	2,7	3,4	5,3	2,7	5,3
Material density	7900	7900	900	1250	1600	1950	1600
Estimated sound wave propagation velocity, m/s	5000 – 6000	5000 - 6000	2000-2500	2200-2700	2500-3000	2500-3000	2500-3000
Weight of 1 m pipe,	13,9	8	1,03	1,3	3,2	2,0	3,2



Noise-absorbing properties of pipes are confirmed by tests at the Institute of building physics named after Fraunhofer, Stuttgart, Germany i.e. a recognized European center dedicated to the study of acoustic characteristics of construction systems.

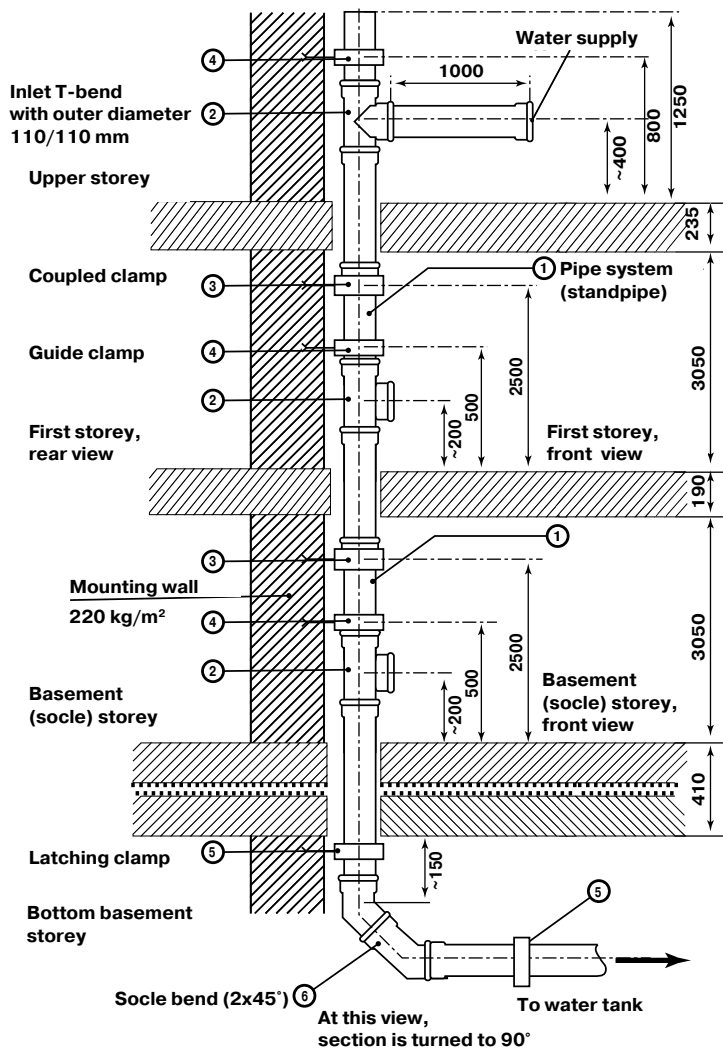

To assess the noise, which the system will generate under the real operating conditions, tests under EN 14366 are conducted, in which a portion of multi-apartment building is simulated.

The test bench has two storeys, basement and garret premises, through which the sewage system standpipe runs being attached to one of the walls. The noise level is measured both inside the premise where this pipe is installed ('test' premise), and in the so-called 'protected' premise located on the other side of this wall. Actual similarity of the test premise in multi-apartment and residential buildings is the restroom, and the common residential rooms are similar to the protected premise.

According to German standard DIN 4109, noise level in these premises at night shall not exceed 30 dB(A). German standard VDI 4100 establishes more stringent requirements i.e. according to this standard, to reach the maximum acoustic comfort, the noise level shall be maximum 24 dB(A) for a multi-apartment building, and maximum 22 dB(A) for a single-family home.

Depending on wastewater flowrate, the following data on the noise level in dB(A) were obtained:

Conditions		Wastewater flowrate, L/s			
		0,5	1,0	2,0	4,0
Tests per EN14366	Test premise	43	45	47	49
	Protected premise	<10	10	12	17
Tests per VDI 4100	Test premise	41	43	44	47
	Protected premise	<10	<10	12	17

The maximum wastewater flowrate, which is used in the calculation of the real sewage system as per SP 30.13330.2016 is 1.6 L/s, and it occurs in it when flushing the toilet tank. During these tests, the maximum flowrate was 4.0 L/s, which 2.5 times more than the real values. But despite this, noise level in the protected premise even for the most stringent standard VDI 4100 was 5 dB(A) below the permissible values. Here, it shall be remembered that the decibel is a logarithmic unit of measurement, and a difference of 5 decibels corresponds to a change in the measured value of about 3.16 times.

Thus, PRO AQUA Style Plus pipe has confirmed its high efficiency in management of noises in the sewage system. Application of these pipes and fittings allows for making internal sewage of a single-family house or apartment in a multi-storey building really noiseless.

INSTALLATION OF FIRE-PROTECTION COLLAR

According to SP 40-107-2003 when crossing an inter-storey floor slab, fire-prevention collar shall be installed. In case of fire and combustion of the pipe, material of collar expands, sealing the opening, preventing the spread of flame and combustion products between storeys. Plug of coked cellular material formed in place of pipe withstands temperatures up to 1000 degrees for 3 hours.

- Perform pipeline installation (if necessary, together with the supplied soundproof flexible housing)

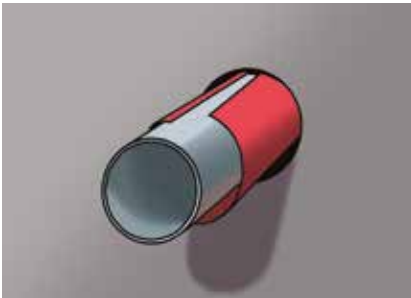

- Seal the gap tightly to prevent smoke/gases from escaping

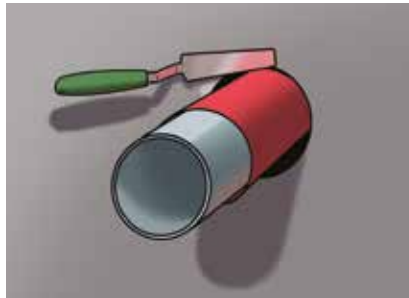

- Select dimensions of the sleeve

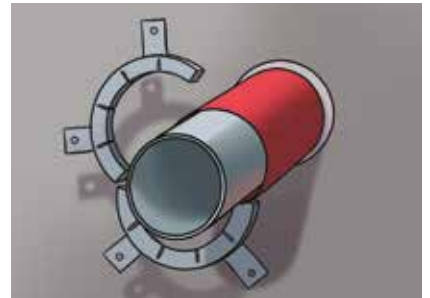

- Mark the attachment points, and drill the openings



- Secure strips with screws and dowels using the supplied mounting kit (alternatively, the strips may be bent at 90°, and embedded into grout.

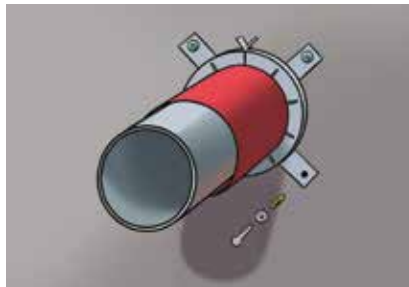

- Fill in the attached table, attach it with embedding.

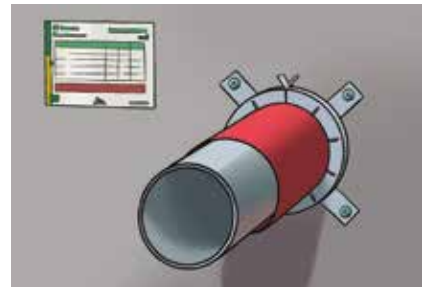

TRANSPORTATION AND STORAGE OF POLYPROPYLENE ARTICLES

Pipes not placed on pallets shall be supported as far as possible along their entire length during transport. Protect the pipes against shock loads, especially at sub-zero temperatures. During handling operations using lifting devices, please apply wide textile belts or similar fixture. Pipes and fittings with installed sealing rings may be stored in the open as far as possible 3 years maximum.

The following shall be considered when storing the pipes:

- a) It is necessary to provide reliable supports that do not cause deformation or bending of pipes for warehousing.
- b) During storage, pipe sockets shall not be exposed to horizontal or vertical loads.
- c) Stacking height shall not exceed 1.5 m.

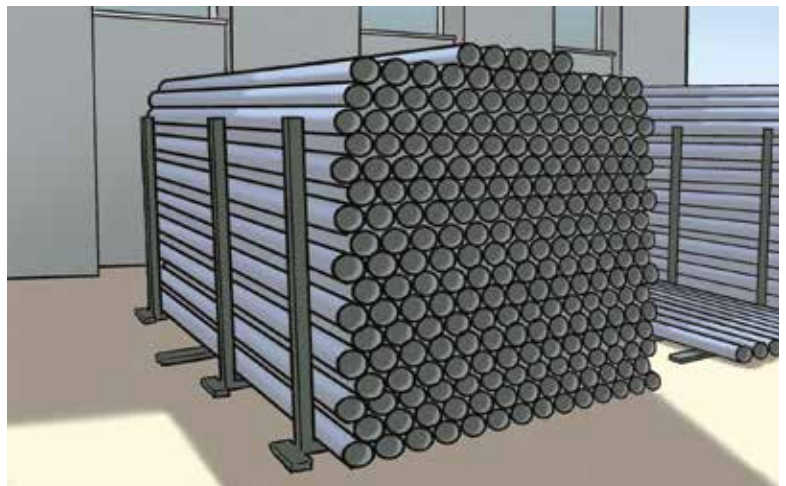

APPROVALS

PRO AQUA STILTE PLUS pipes and fittings are produced according to TU 2248-011-16965449-2016, which is witnessed by the certificate No. POCC RU.AЯ12.H01303 dated March 23, 2018. The articles are not subject to mandatory certification.

Pipes and fittings PRO AQUA STILTE PLUS was tested in Fraunhofer institute of Building Physics, test report №P-BA 15/2019e

PRO AQUA STILTE PLUS pipes and fittings not designed to contact with drinking water, so the system don't need hygienic certificate.

ДОБРОВОЛЬНАЯ СЕРТИФИКАЦИЯ ПРОДУКЦИИ

СЕРТИФИКАТ СООТВЕТСТВИЯ

№ POCC RU.HB65.H01316/21
Срок действия с 30.04.2021 по 29.04.2024
№ 0051778

ОРГАН ПО СЕРТИФИКАЦИИ per № RA.RU.1110665, Орган по сертификации Общества с ограниченной ответственностью «Сертификация и качество», 125080, РОССИЯ, город Москва, шоссе Волоколамское, дом 1, строение 1, этаж 3 помещение VI, комната 30А (PMS), Тел: +7 9956559388, E-mail: ant.quality@gmail.com

ПРОДУКЦИЯ Трубы и фасонные части с усиленным полимерным покрытием «STILTE» и «STILTE PLUS» для систем внутренней канализации по ТУ 2248-011-16965449-2016
Серийный выпуск код ОК Код ОК 034-2014 (КПЕС 2008) 22.21.29

СООТВЕТСТВУЕТ ТРЕБОВАНИЯМ НОРМАТИВНЫХ ДОКУМЕНТОВ ТУ 2248-011-16965449-2016 код ТИ ВДА 3917 22 100 0, 3917 40 000 9

ИЗГОТОВИТЕЛЬ Общество с ограниченной ответственностью «НАУЧНО-ПРОИЗВОДСТВЕННОЕ ОБЪЕДИНЕНИЕ «ПРО АКВА» (ООО НПО «ПРО АКВА»). Место нахождения: 141370, Россия, область Московская, Сергиево-Посадский район, город Хотьково, проезд Художественный, дом 2А, помещение 5, ИИН 5042139897, ОГРН 1155042064138. Адрес места осуществления деятельности по производству продукции: 141370, Московская область, Сергиево-Посадский район, город Хотьково, Художественный проезд, дом 2А

СЕРТИФИКАТ ВЫДАН Обществу с ограниченной ответственностью «НАУЧНО-ПРОИЗВОДСТВЕННОЕ ОБЪЕДИНЕНИЕ «ПРО АКВА» (ООО НПО «ПРО АКВА»). Место нахождения: 141370, Россия, область Московская, Сергиево-Посадский район, город Хотьково, проезд Художественный, дом 2А, помещение 5, ИИН 5042139897, ОГРН 1155042064138. Телефон: +74959930079 Адрес электронной почты: info@proaqua.ru

НА ОСНОВАНИИ Протоколов испытаний №№ 027/21, 028/21 от 30.04.2021 года, выданных Исполнительной лабораторией «ПЛАСТ ТЕСТ» ООО «Арктикполимер» (регистрационный номер аттестата аккредитации RA.RU.2103602).

Сертификат соответствия системы менеджмента качества требованиям ГОСТ Р ИСО 9001-2015 (ISO 9001:2015) от № POCC RU.ФК38.К30076, дата регистрации 27.08.2018

ДОПОЛНИТЕЛЬНАЯ ИНФОРМАЦИЯ Схема сертификации: Зс

Руководитель органа Эксперт
О.В. Кривошеина
Д.В. Туркин

Сертификат не применяется при обязательной сертификации

Fraunhofer IBP

Institute for testing, supervision and certification, officially recognized by the building supervisory authority. Approval of new building material, components and types of construction.

Director: Prof. Dr. phil. Gerd Pfeifer
Prof. Dr. Klaus Peter Jochbauer

Test Report P-BA 15/2019e

Determination of the Acoustic Performance of a Wastewater Installation System in the Laboratory according to EN 14366

Client: Limited Liability Company Scientific-production association «PRO AQUA», Russian Federation, 141370, Moscow oblast, Serгиеvo-Posadskii district, Khotkovo city, Khudozhenskiy prosed, 2A, room 5

Test object: Wastewater system "POLYTRON STILTE PLUS LOW NOISE TPX DN110x5.3, 14.12.18" (manufacturer: Limited Liability Company Scientific-production association «PRO AQUA»). The wastewater system consisted of straight plastic pipes and fittings and acoustic pipe clamps with electric inlay "DN 110 POLYTRON STILTE Plus" (manufacturer: Limited Liability Company Scientific-production association «PRO AQUA»)

Content: Results sheet 1: Summary of test results
Figures 1 to 3: Detailed results
Figures 4 and 5: Test set-up
Annex A: Measurement set-up, noise excitation, acoustic parameters
Annex F: Evaluation of measurements
Annex P: Description of the test facility
Annex V: Assessment according to VDI 4100

Test date: The measurement was carried out on January 24, 2019 in the test facilities of the Fraunhofer Institute for Building Physics in Stuttgart.

Stuttgart, April 9, 2019
Responsible Test Engineer:  Head of Laboratory: 
Dr.-Ing. J. Mohr M.B.P. Dipl.-Ing. J.H.G. S. Öster

The test was carried out in a laboratory, accredited according to DIN EN ISO 17025:2005 by DAkkS. The accreditation certificate is D-PL-11140-11-01.

Any publication of this document in part is subject to written permission by the Fraunhofer Institute for Building Physics (IBP).

Fraunhofer-Institut für Bauphysik · Prüflabor Bauphysik und Schallmesstechnik
Aldenstraße 17, D-70569 Stuttgart
Telefon +49 71 4570 2714, Fax 3404
ibp@ibp.fraunhofer.de
www.prueflabor.ibp.fraunhofer.de/ibp/ibp-erklaerung-prueflabor.html





proaquasystem.com



Fraunhofer

tested by
Fraunhofer IBP

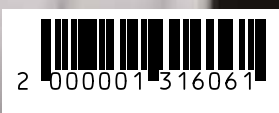

2 000001 316061